

# Nordic CL4

ART.NO. 800220, 800221

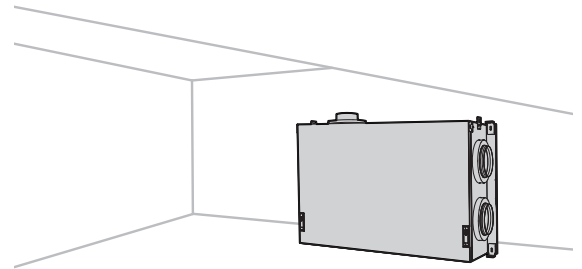

Ventilation unit for ceiling installation in flats, small houses and accommodation blocks.



## Product features

- Installation in ceiling or cold attic/loft
- Very silent, below 35 db(A) 10m<sup>2</sup> Sabine
- Low weight & building height < 30 cm
- Control through app and cloud services
- Configurable door solution

## Automatic control

The Flexit GO app



Google Play



App Store



A NordicPanel control panel can be ordered as an accessory.

## Description

Flexit Nordic CL2 air handling units have been developed to be energy efficient in Nordic climate.

Fits well in apartments, detached houses, villas and small commercial buildings.

Connection option for kitchen hood via bypass solution.

The unit has high-efficiency rotary heat exchangers, with a temperature efficiency of up to 85%, and fans with low power consumption.

Low building height makes the unit excellent for ceiling mounting or mounting in cold attic.

With configurable door, you can choose which direction to open the door.

All Nordic units are controlled as standard via the Flexit GO app and can be supplemented with various accessories, eg. control panel, humidity sensor, pressure sensor for kitchen hood, CO<sub>2</sub> sensor etc.

The control system is prepared for local needs control.

Cooling recovery is a standard feature in the Nordic series.

With Flexit GO you can also activate the function free / night cooling.

At high humidity, the defrost function ensures operation in cold climates.

	GTIN	Model
800220	7023678002209	Nordic CL4 RER right-hand model with electric battery
800221	7023678002216	Nordic CL4 REL left-hand model with electric battery

## Technical data

CL4 RE with electric battery		
POWER	Rated voltage (AC 50 Hz)	230 V
	Frequency	50 Hz
	Fuse size	10 A
	Rated current	4,5 A
	Rated power, total	1 050 W
	Rated power, max. electric battery	800 W
	Rated power, fans	2 x 115 W
	Rated power, rotor motor	4 W
	IP class*	21

VENTILATION	Fan type	B-wheel
	Fan motor control	0-10 V
	Max. fan speed RPM	3,200
	Automatic control	Flexit GO
	Filter class	ePM1 55% (F7)
	Filter type (supply air/extract air)	Compact filter

DIMENSIONS	Filter dimensions (WxHxD)	290 x 230 x 48 mm
	Kitchen fan connection	Ø 125 mm
	Weight, ventilation unit	58 kg
	Weight, rotor	11,3 kg
	Weight, door	12,5 kg
	Weight, fan	1,8 kg
	Duct connection	Dia. 160 mm
	Height	700 mm
	Width	1160 mm
	Depth	296 mm

COATING	Colour	White
	RAL	9016
	Gloss	25-35

\*For installation on a ceiling

Energy class:



CTRL 0.65

### LOCAL DEMAND CONTROL

Sensor control for different zones

**Accessories:** App + CO<sub>2</sub> sensor/motion sensor + damper

**Result:** Increased air flow rate in zones that need it

Dimensioned drawings

Dimensions in mm

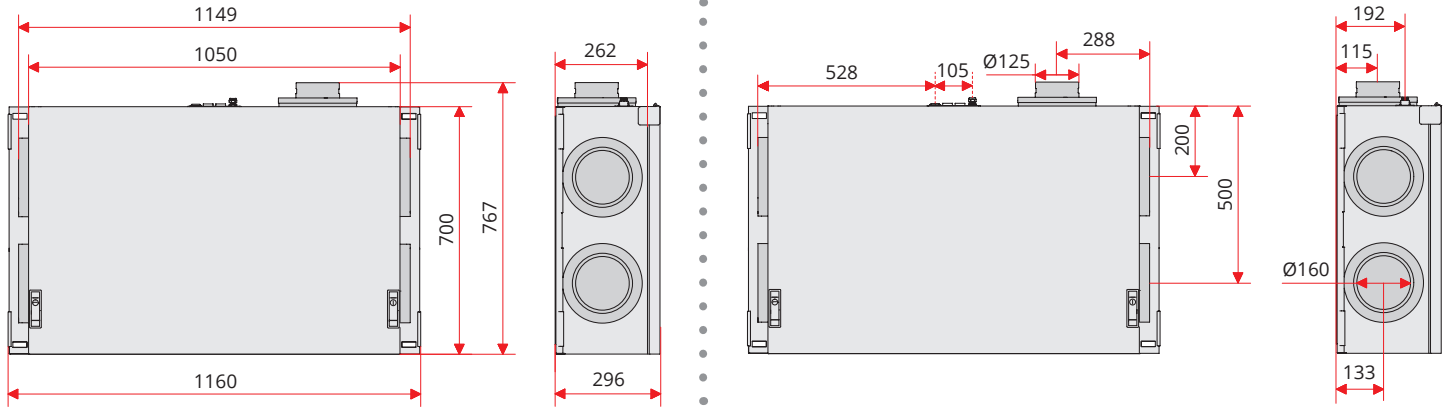

## Capacity diagram

### Supply air side L

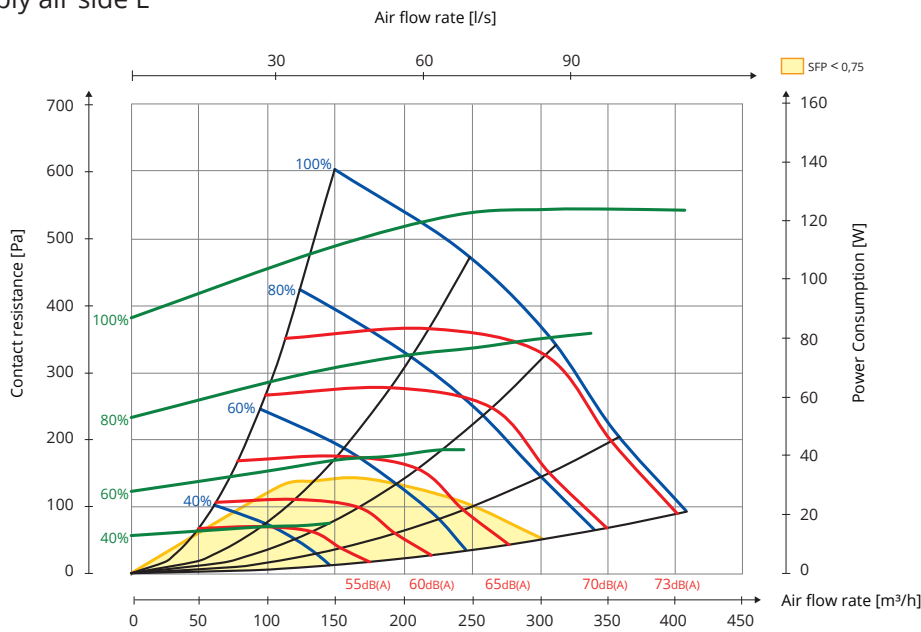

### Extract air side L

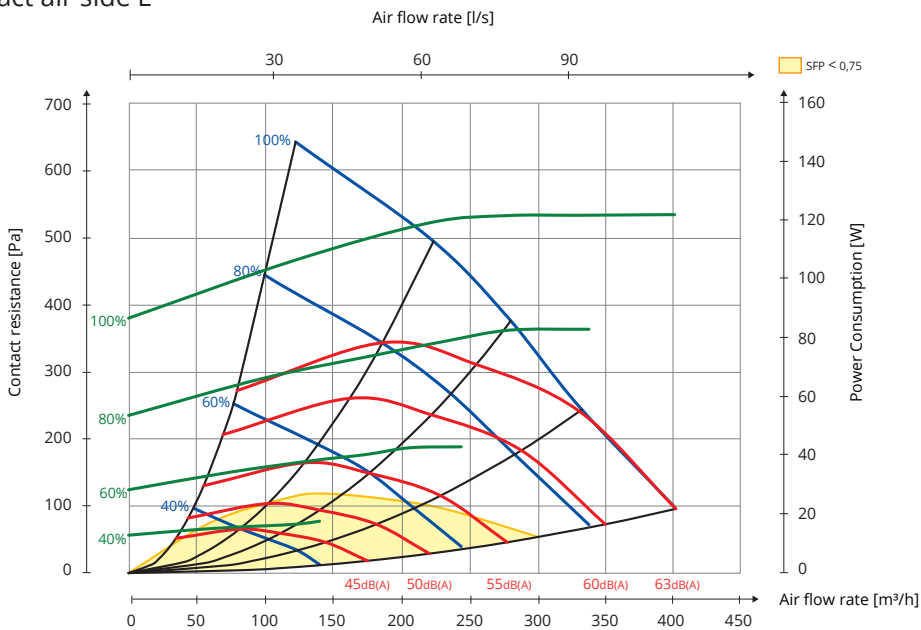

Hz	63 Lw(dB)	125 Lw(dB)	250 Lw(dB)	500 Lw(dB)	1000 Lw(dB)	2000 Lw(dB)	4000 Lw(dB)	8000 Lw(dB)	LwA (dBA)
Supply air	3	4	3	-4	-9	-8	-14	-20	
Extract air	9	9	6	-6	-16	-18	-31	-32	
Radiated sound 1	-11	-17	-15	-21	-28	-28	-31	-39	-19
Radiated sound 2 (integrated)	-11	-22	-21	-32	-37	-37	-41	-48	-27

#### Explanation of diagram:

Sound data is specified as sound power level LwA in the capacity diagrams. (This is sound to duct.)

These values can be corrected by means of the table for the different octave bands in order to look at Lw (without adaptation to A band).

The correction table for the various octaves is stated in Lw, which means that the Lw values are after conversion of each octave for supply air and extract air.

Radiated sound from the unit must be calculated from the supply air diagram.

Supply air side R

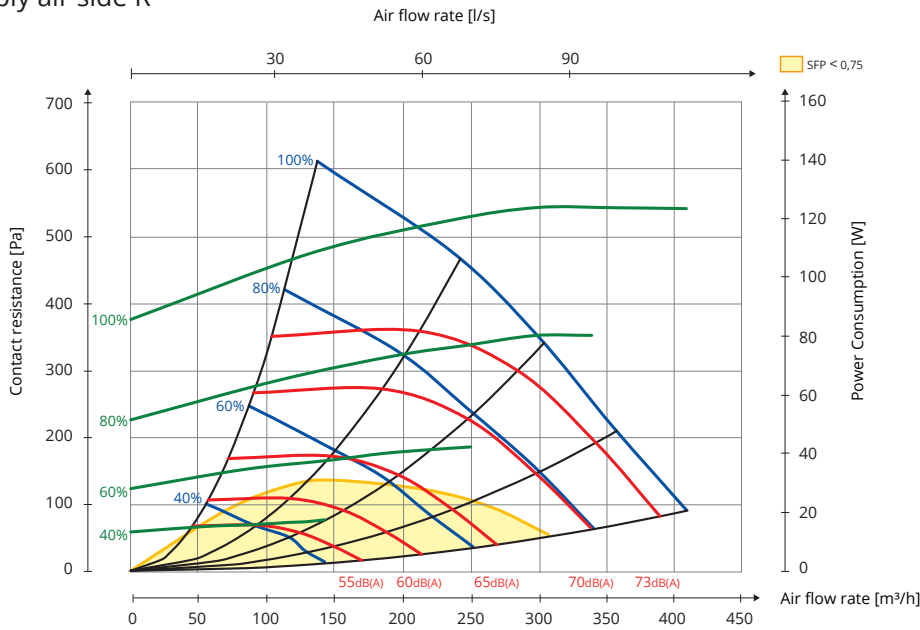

Extract air side R

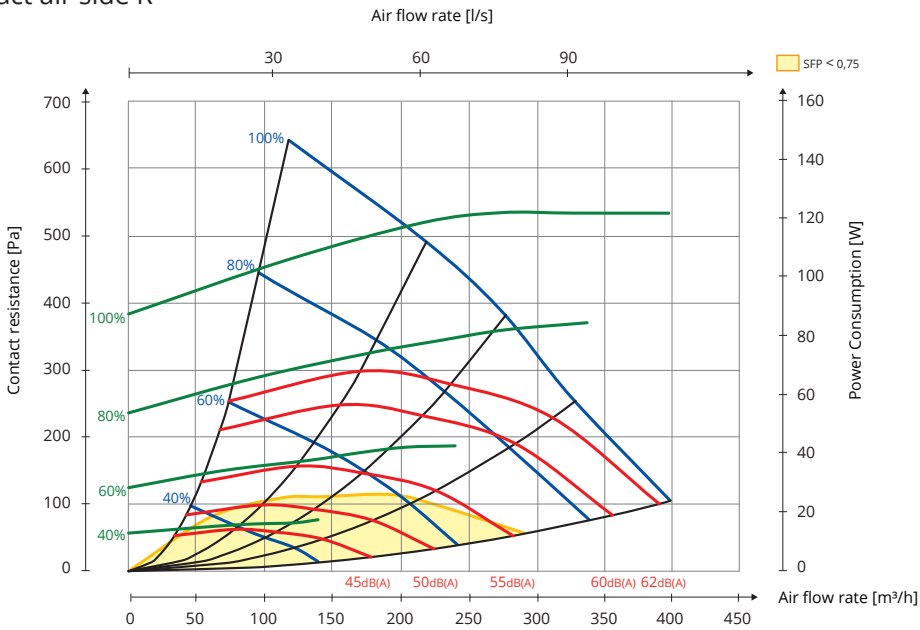

Hz	63 Lw(dB)	125 Lw(dB)	250 Lw(dB)	500 Lw(dB)	1000 Lw(dB)	2000 Lw(dB)	4000 Lw(dB)	8000 Lw(dB)	LwA (dBA)
Supply air	4	4	3	-5	-8	-8	-14	-21	
Extract air	7	9	6	-6	-14	-15	-26	-30	
Radiated sound 1	-11	-17	-15	-21	-28	-28	-31	-39	-19
Radiated sound 2 (integrated)	-11	-22	-21	-32	-37	-37	-41	-48	-27

Explanation of diagram:

Sound data is specified as sound power level LwA in the capacity diagrams. (This is sound to duct.)

These values can be corrected by means of the table for the different octave bands in order to look at Lw (without adaptation to A band).

The correction table for the various octaves is stated in Lw, which means that the Lw values are after conversion of each octave for supply air and extract air.

Radiated sound from the unit must be calculated from the supply air diagram.

## Position

The unit can be installed in the following ways:

1. On the ceiling.
2. On the wall (mounting is available as an accessory)
3. Horizontally on the floor (absorption feet are available as an accessory or use damping blocks supplied with the ceiling suspension)
4. Vertically on the floor (absorption feet are available as an accessory or use damping blocks supplied with the ceiling suspension)

The CL4 is available in both a right and a left version, depending on what best matches the duct location.

The unit can be located in a cold zone such as the loft.

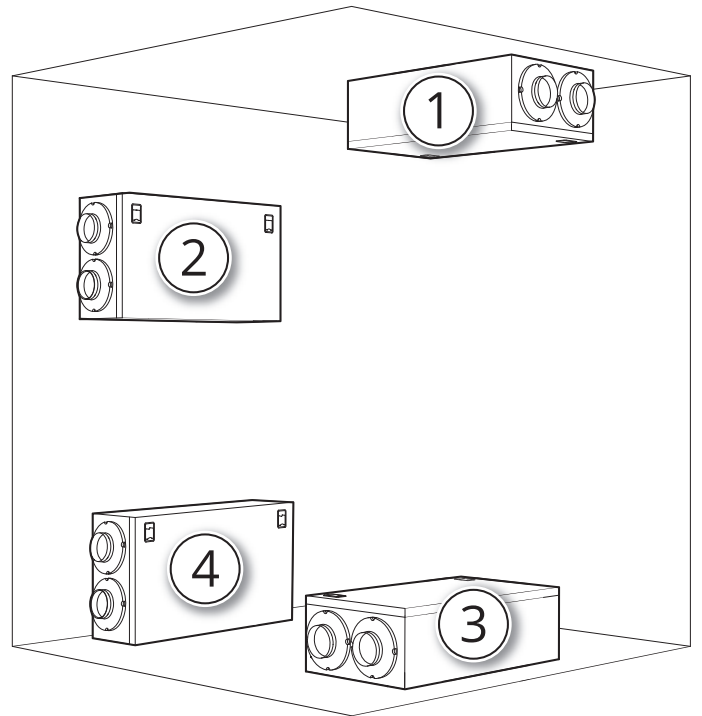

## Nipple location

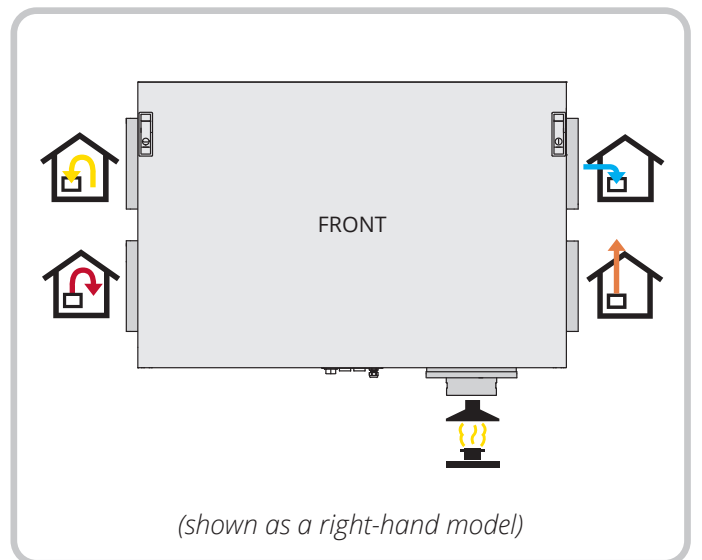
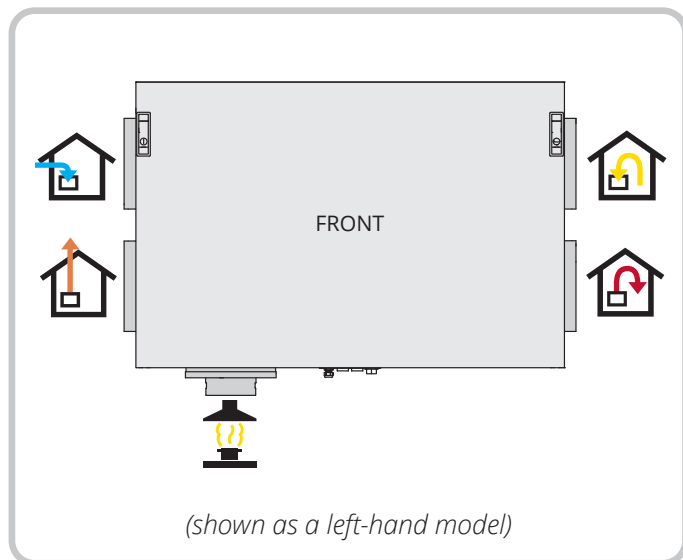

For more information on topics including installation, wiring diagrams and accessories, see [www.flexit.com](http://www.flexit.com)





Flexit participates in the ECP programme for RAHU.  
Check ongoing validity of certificate:  
[www.eurovent-certification.com](http://www.eurovent-certification.com)

The product is listed in the database for building products that can be used in Nordic Swan Ecolabelled buildings.

